

## LALIZAS Liferaft DEEP SEA II, Throw Overboard

**SOLAS / MED / TC APPROVED**



- SOLAS/MED/TC approved (fully compliant with MED 2014/90/EU, Chapter III of SOLAS 1974, including all subsequent amendments)
- Available with SOLAS Pack A or SOLAS Pack B equipment configurations, in capacities ranging from 6 to 25 persons
- Available in canister or flat-pack options, offered in both standard and compact versions
- The compact flat-pack version is the most space-efficient SOLAS-approved liferaft, specifically designed for the mega-yacht sector to optimise stowage and save valuable space on board
- Designed to inflate and operate in an outdoor temperature range of  $-15^{\circ}\text{C}$  to  $+65^{\circ}\text{C}$
- Annual inspection interval, according to SOLAS requirements

Model	Dimensions (mm)		
	A	B	C
SOLAS DEEP SEA II 6	1990	1990	1210
SOLAS DEEP SEA II 8	2270	2270	1300
SOLAS DEEP SEA II 10	2550	2550	1410
SOLAS DEEP SEA II 12	2690	2690	1490
SOLAS DEEP SEA II 16	3380	3380	1620
SOLAS DEEP SEA II 20	4280	4280	2330
SOLAS DEEP SEA II 25	4280	4280	2330

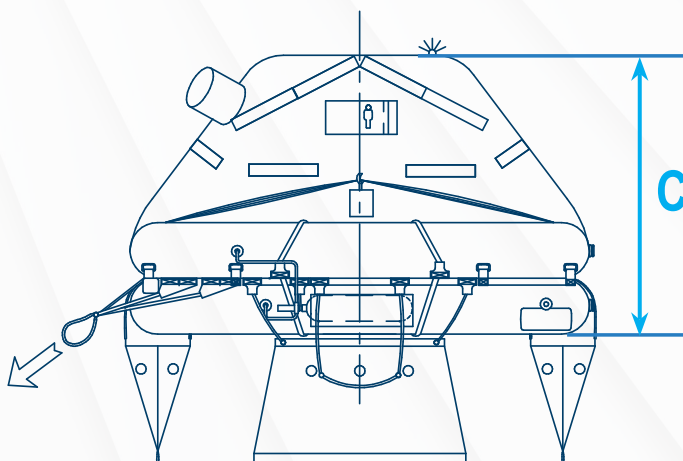
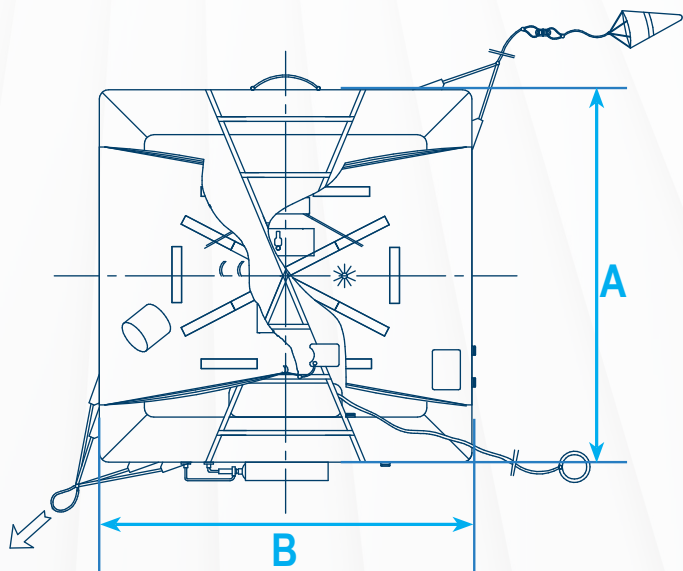

**PACK A**

Code	501595	501596	501597	501598	501599	501600	501601
Persons	6	8	10	12	16	20	25
Container	Roll						
Canister Material	GRP						
Total Weight (kg)	84	98	106	118	153	169	178
X - Length (mm)	1180	1180	1320	1320	1460	1590	1590
Z - Width (mm)	640	640	640	640	710	730	730
Y - Height (mm)	590	590	590	590	610	640	640
Max. Storage Height (m)	25						

Code	501625	501626	501627
Persons	6	8	10
Container	Flat		
Canister Material	GRP		
Total Weight (kg)	84	96	105
X - Length (mm)	850	860	860
Z - Width (mm)	610	620	620
Y - Height (mm)	350	450	450
Max. Storage Height (m)	18		

Code	501617	501618	501619	501620
Persons	6	8	10	12
Container	Roll Compact			
Canister Material	GRP			
Total Weight (kg)	73	81	91	107
X - Length (mm)	1180	1180	1180	1180
Z - Width (mm)	560	560	560	640
Y - Height (mm)	530	530	530	590
Max. Storage Height (m)	18			

Code	501609	501610	501611	501612
Persons	6	8	10	12
Container	Flat Compact			
Canister Material	ABS			
Total Weight (kg)	64	77	90	108
X - Length (mm)	740	860	860	1050
Z - Width (mm)	480	620	620	570
Y - Height (mm)	390	350	350	350
Max. Storage Height (m)	18			



**Roll Compact (GRP)**



**Flat Compact (ABS)**

**PACK B**

Code	501602	501603	501604	501605	501606	501607	501608
Persons	6	8	10	12	16	20	25
Container	Roll						
Canister Material	GRP						
Total Weight (kg)	71	76	81	92	109	118	125
X - Length (mm)	1180	1180	1180	1320	1320	1460	1460
Z - Width (mm)	640	640	640	640	640	710	730
Y - Height (mm)	590	590	590	590	590	610	640
Max. Storage Height (m)	25						

Code	501628	501629	501630
Persons	6	8	10
Container	Flat		
Canister Material	GRP		
Total Weight (kg)	64	73	79
X - Length (mm)	730	850	850
Z - Width (mm)	480	610	610
Y - Height (mm)	340	350	350
Max. Storage Height (m)	18		

Code	501621	501622	501623	501624
Persons	6	8	10	12
Container	Roll Compact			
Canister Material	GRP			
Total Weight (kg)	58	67	70	77
X - Length (mm)	1180	1180	1180	1180
Z - Width (mm)	560	560	560	640
Y - Height (mm)	530	530	530	590
Max. Storage Height (m)	18			

Code	501613	501614	501615	501616
Persons	6	8	10	12
Container	Flat Compact			
Canister Material	ABS			
Total Weight (kg)	52	59	64	79
X - Length (mm)	740	860	860	1050
Z - Width (mm)	480	620	620	570
Y - Height (mm)	350	320	320	350
Max. Storage Height (m)	18			



**Flat Compact - 12 persons (GRP)**

# Global Service & Supply Network



- ✓ Global **service network** through owned locations & third-party service providers
- ✓ Global **supply** of **LSA**, **FFE** and **spare parts**
- ✓ Certified quality standards by **major classification societies**
- ✓ **Robust warranty** supported directly by the manufacturer
- ✓ Streamlined **after-sales support** via our ticketing system

***Safety is not just a product, it is an ongoing process!***